





Oceanpower

Ice cream machine







Spare parts lists

Transmission accessories

Number	Image	Name	Specification	Unit /Machine	Price Per Unit incl VAT
1		Gear reducer		1	R4700
2		Motor	220V	1	R 3500
3		Beater	pom material	1	R1400
4		Ripple sealed o-ring		2	R60





3		Main Condenser		1	US\$4000
4		Condenser for pre-cooling		1	R1260
5		Air tube		1	R125
6		Main Fan		1	R2175
7		Fan for pre-cooling		1	R1260
1		Compressor 220V		1	R8000
8		Cover of Hopper		1	R270



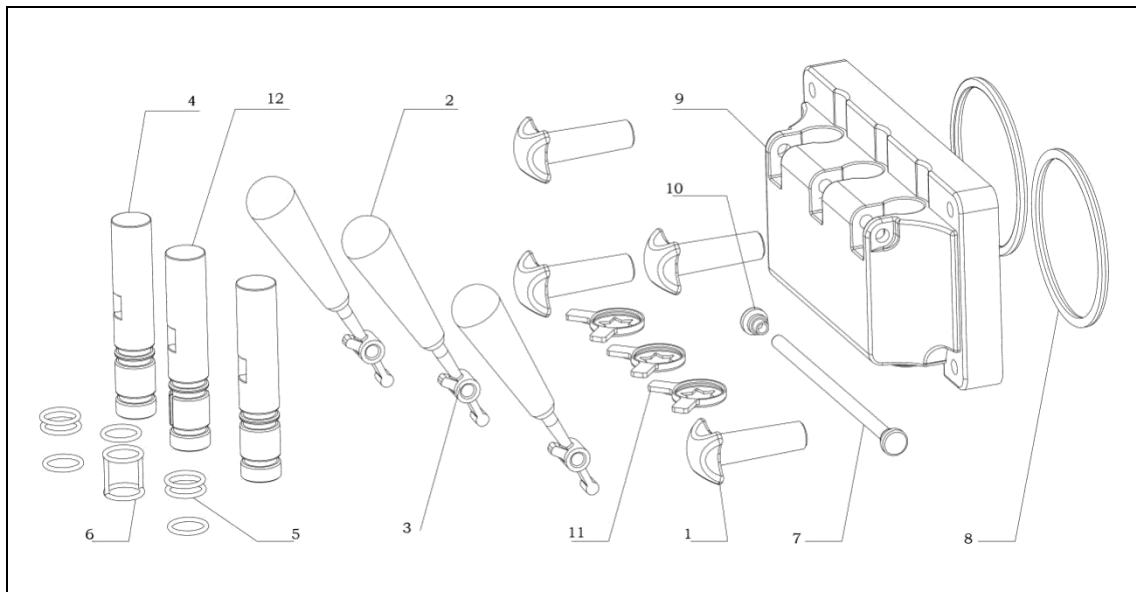



Electrical accessories

Number	Image	Name	Specification	Unit /Machine	Price Per Unit
1		Control panel face		1	R150
2		AC contactor		2	R470
3		control transformer		1	R525
4		Switch		1	R300
5		Driven board		1	R2500 new Exchange R1750
6		Display board		1	R2250

Discharge door









Number	Image	Name	Specification	Unit /Machine	Price Per Unit
1		Hand screw		1	R95
2		Distribution handle		1	R150
4		Side draw valve		1	R195
5		draw valve O-ring		1	R15 Full set of O rings R280

6		Centre draw valve o- ring		1	R45
7		Pivot pin		1	R445
8		discharge door o-ring		1	R35
9		Discharge door body	normal / air pump model	1	R1400
11		Design cap		3	R50
12		Centre draw valve		1	450

Others

Number	Image	Name	Specification	Unit /Machine	Price Per Unit
--------	-------	------	---------------	---------------	----------------

1		Big drip trap (at the front of machine)	table top model stand model	1 set	R1350
2		Drip trap (at the side of machine)		1	R60
5		Asbestos shim (between gear reducer and cylinder)		1	180
6		Plastic stopples		2	350
7		cone holder		1	650

19		small strap wheel		1	US\$10
20		Driven strap		3	US\$10
21		Hand Screw		1	US\$5
22		AC contactor		2	US\$25
23		Magnetic switch		1	US\$5
24		water cooling condenser		1	US\$130

Remarks:

1. The accessories above are the main accessories of Oceanpower machine. To purchase the accessories that are not in the list, please contact Oceanpower Sales department or **info@oceanpower.com**.
2. For different types of machine, the specification and brand of accessories may be different, please provide model name and purchase year when you buy accessories.

nota:

1. Los accesorios arriba son los accesorios principales de las máquinas de Oceanpower. Para comprar los accesorios que no están en la lista, póngase en contacto con el departamento de negocios de Oceanpower o **info@oceanpower.com**.
2. Diferentes modelos puede con accesorios de diferente especificación y marca. Proporcione por favor el nombre del modelo y el año de la compra cuando usted quiere adquirir accesorios.

Shenzhen Oceanpower Ecological Food Science and Technology Co., Ltd.

Add: Block C&D, 7&8/F, Bldg. F3.8, Tian'an Cyber Park, Chegongmiao, Shenzhen,
China

Web: www.oceanpowerfood.com

Phone: 86-75583897272

Email: info@oceanpower.com

